

Baneveien Lier Omlegging av kjørevei og etablering av GS-vei

-
-

Lier kommune

TEKNISKE DATA

Fra – til profil: Pr.20000 – 20920
Dimensjoneringsklasse: –
Fartsgrense: 30 og 50 km/t
Trafikkgrunnlag: Anslått ÅDT 400



STENER SØRENSEN

Utarbeidet av:

Hovedprosjektnummer: –
Delprosjektnummer: –
Prosjektfasenummer: –

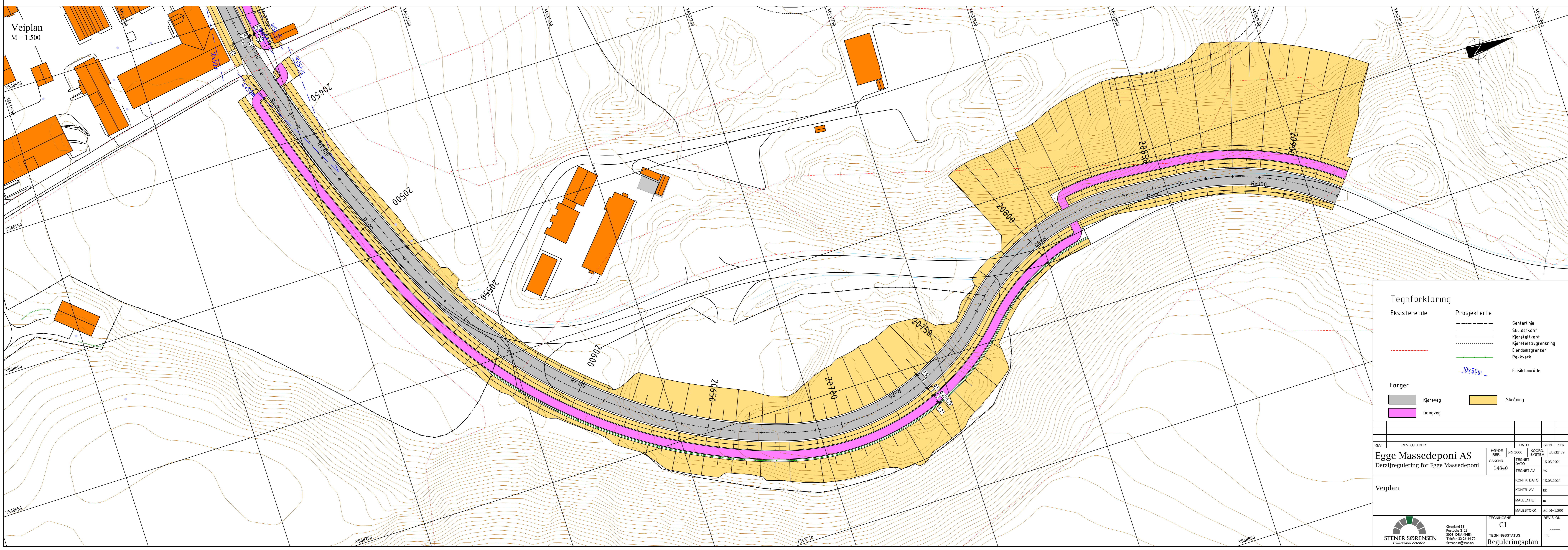
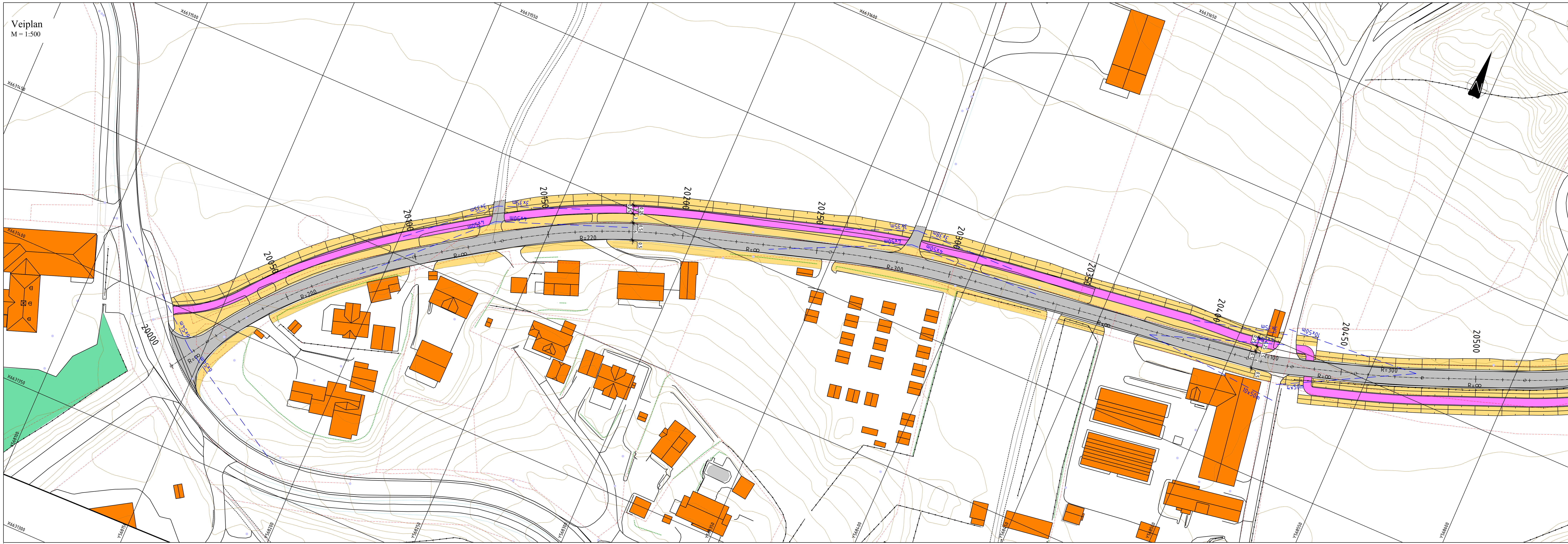

Tegnforklaring

	Eksisterende		Prosjekterte		Senterlinje
					Skulderkant
					Kjøreflatekant
					Kjøreflatebegrensning
					Eiendomsgrænser
					Rekkverk
					Friskområde

Farger

	Kjøreveg		Skråning
	Gangveg		

REV.	REV. GJELDER	DATE	SIGN.	KTR.
EGGE MASSEDEPONI AS Detaljregulering for Egge Massedeponi		HØYDE REF. SN 2000	KOORD. SYSTEM	ELSREF. # 11.03.2021
		SAKSNR. 14840	TEISET DATO. 15.03.2021	TEISET AV. YS
Veiplan		MONTR. DATO. 15.03.2021	MONTR. AV. YS	RE.
		MALEENHET. m	MALEENHET. m	MALEENHET. m
		MALESTOKK. A4: M=1:500	MALESTOKK. A4: M=1:500	MALESTOKK. A4: M=1:500
STENER SØRENSEN 8100 ANSLAG LANDSAP		Grøntel 53 Postboks 112 3901 GRAMPHEN Telefon: 22 28 44 70 E-post: info@stener.no	TEISET C1	REVISJON FIL
		TEISET C1	TEISET C1	TEISET C1

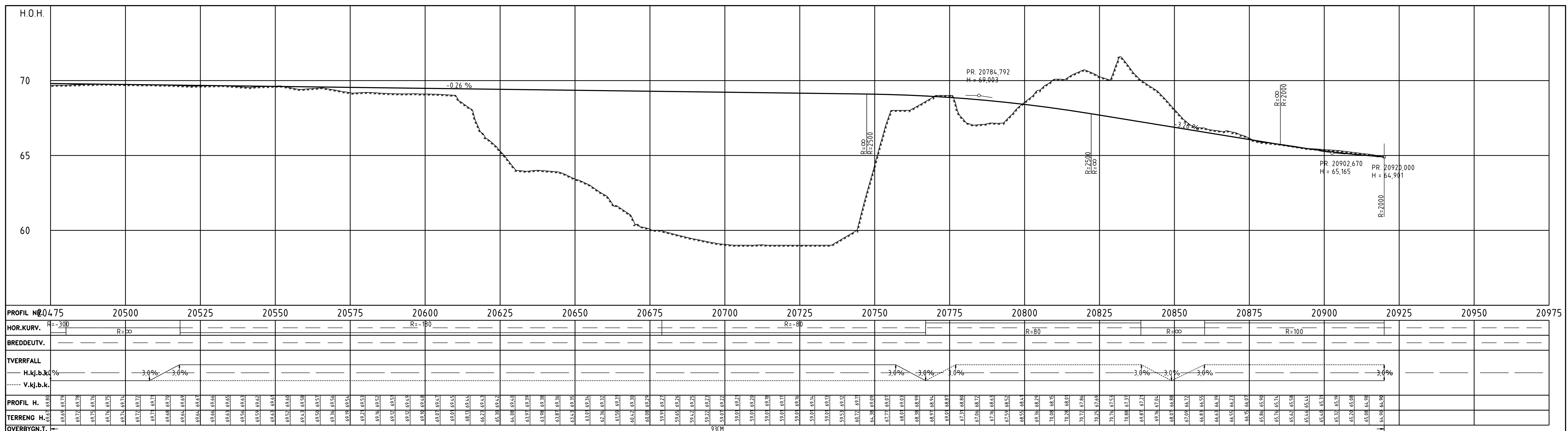
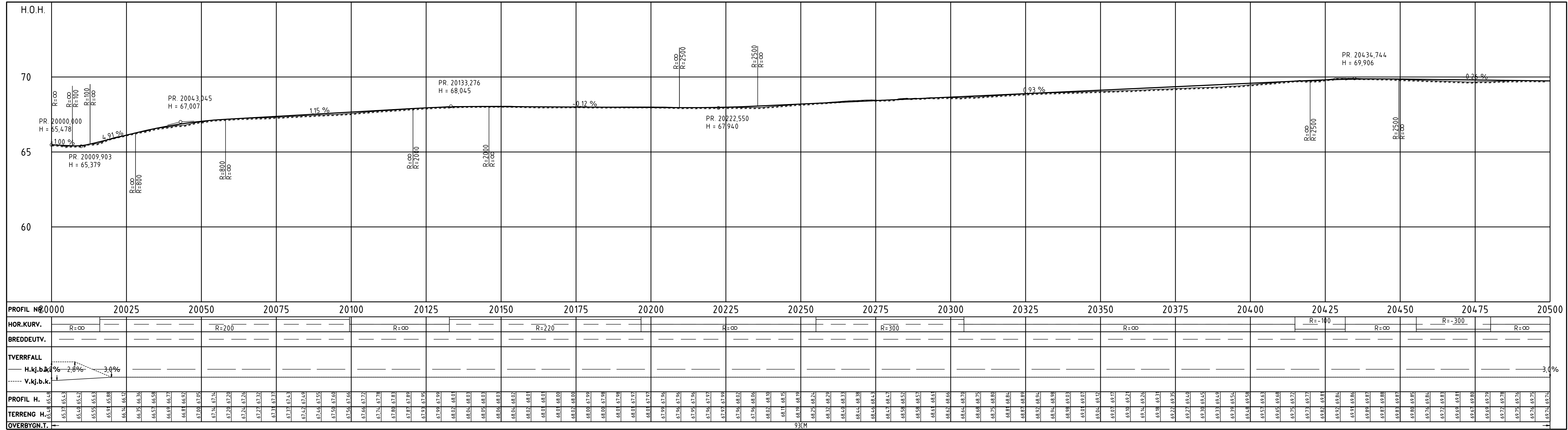

REV.:	REV. GJELDER	DATE	SIGN.	KTR.
REV. 1		13.03.2021		
STENER SØRENSEN		TEGNINGSNØR D1		REVISJON
KONT. AV: MAALESTOKK: 1:1		TEG. AV: MAALESTOKK: 1:1		PROJ. AV: MAALESTOKK: 1:1

STENER SØRENSEN
Grøntand 33
Postboks 115
3001 DRAMMEN
Telefon 31 36 44 70
stener@stener.no

Reguleringsplan

NORMALPROFIL

M=1:50

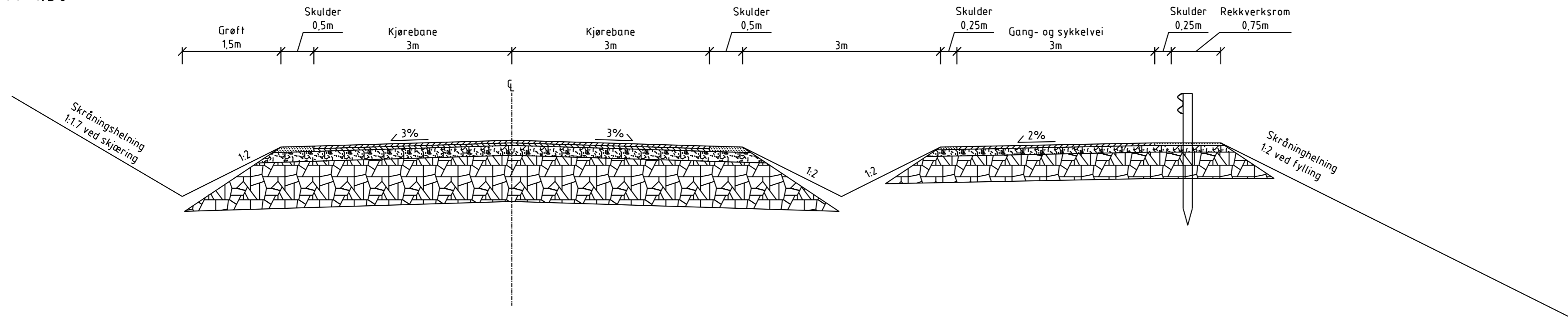

OVERBYGNING NY VEI UNDERGRUNN JORD

M=1:10

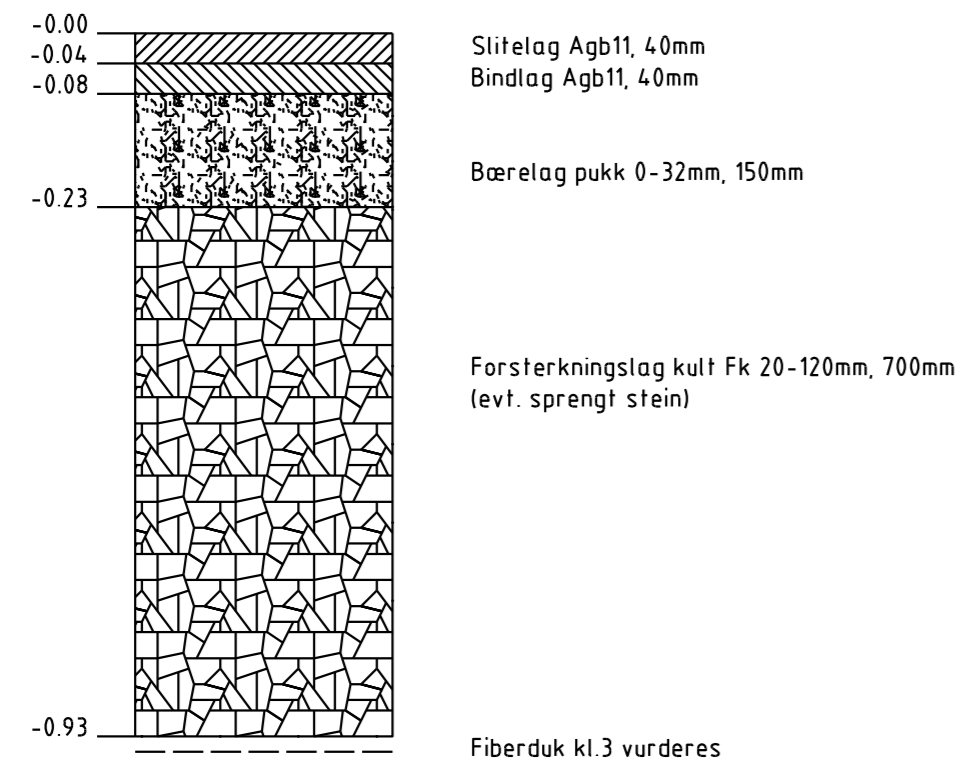

OVERBYGNING NY GS-VEI UNDERGRUNN JORD

M=1:10

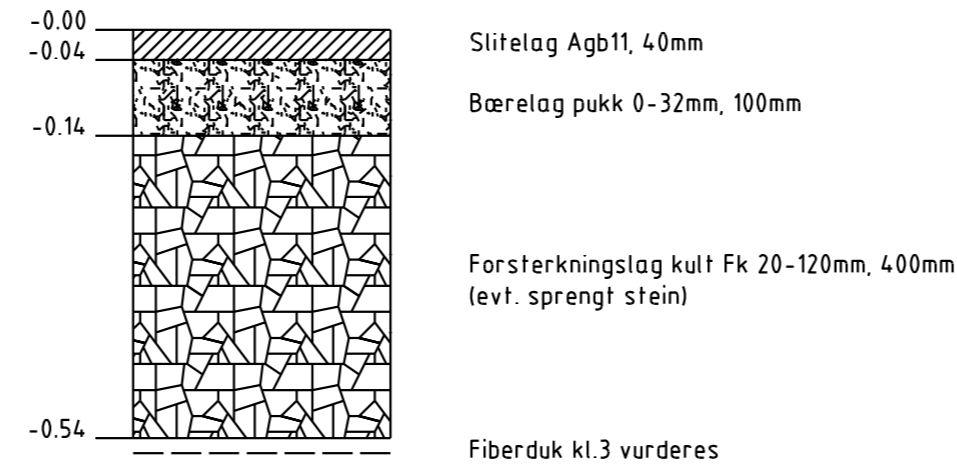

OVERBYGNING NY VEI UNDERGRUNN STEIN

M=1:10

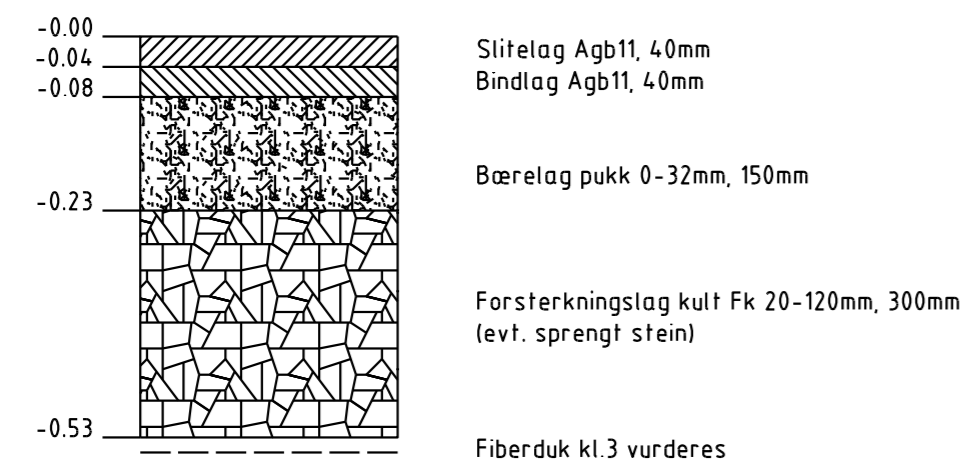



OVERBYGNING NY GS-VEI UNDERGRUNN STEIN

M=1:10

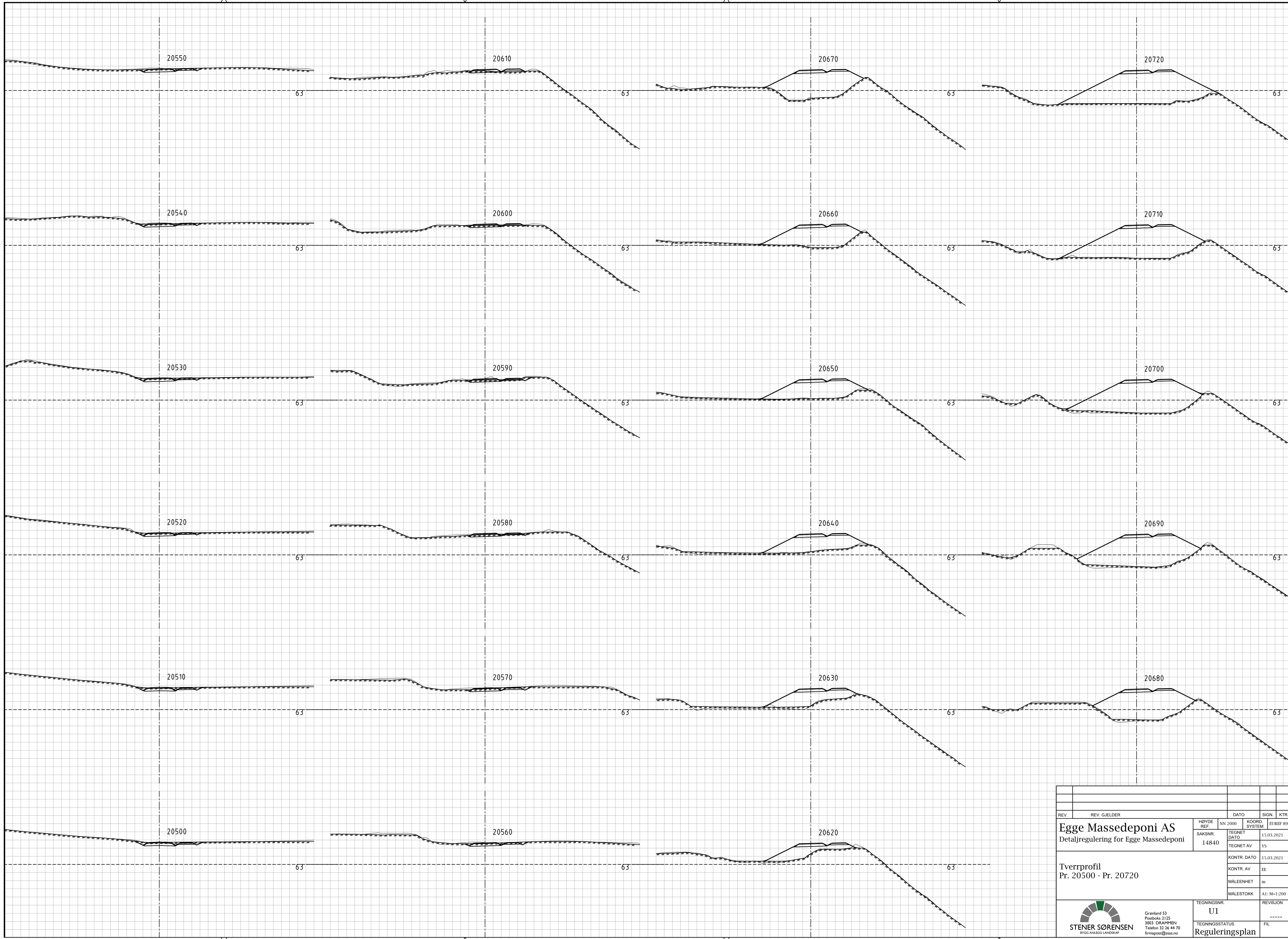

REV.	REV. GJELDER	DATE	SIGN.	KTR.
Egge Massedeponi AS Detaljregulering for Egge Massedeponi		HØYDE REF. NN 2000 SAKSNR. 14840	KOORD. SYSTEM TEGNET DATO TEGNET AV	EUREF 89 15.03.2021 YS
Normalprofil Overbygning		KONTR. DATO	15.03.2021	
		KONTR. AV	EE	
		MÅLEENHET	m	
		MÅLESTOKK	A2: Se tegning	
 STENER SØRENSEN BYGG ANLEGG LANDSKAP		TEGNINGSNR.	F1	
Grønland 53 Postboks 2125 3003 DRAMMEN Telefon 32 26 44 70 firmapost@ssas.no		TEGNINGSSTATUS	Reguleringsplan	
		REVISJON	-----	
		FIL	FIL	



REV.	REV. GJELDER	HOYDE REF.	NN 2000	KOORD. SYSTEM	DATO	SIGN.	KTR.
		14840			15.03.2021		
EGGE MASSEDEPONI AS Detaljregulering for Egge Massedeponi					TEGNET DATO	15.03.2021	
Tverrprofil Pr. 20500 - Pr. 20720					TEGNET AV	YS	
					KONTR. DATO	15.03.2021	
					KONTR. AV	EE	
					MALEENHET	m	
					MALESTOKK	A1: M=1:200	
					TEGningsnr.	U1	REVISJON
					TEGningsstatus	Reguleringsplan	----
 Stener Sørensen BYGG ANLEGG LANDSKAP					Grenland 53 Postboks 2125 3003 DRAMMEN Telefon 32 26 44 70 firmapost@stas.no		

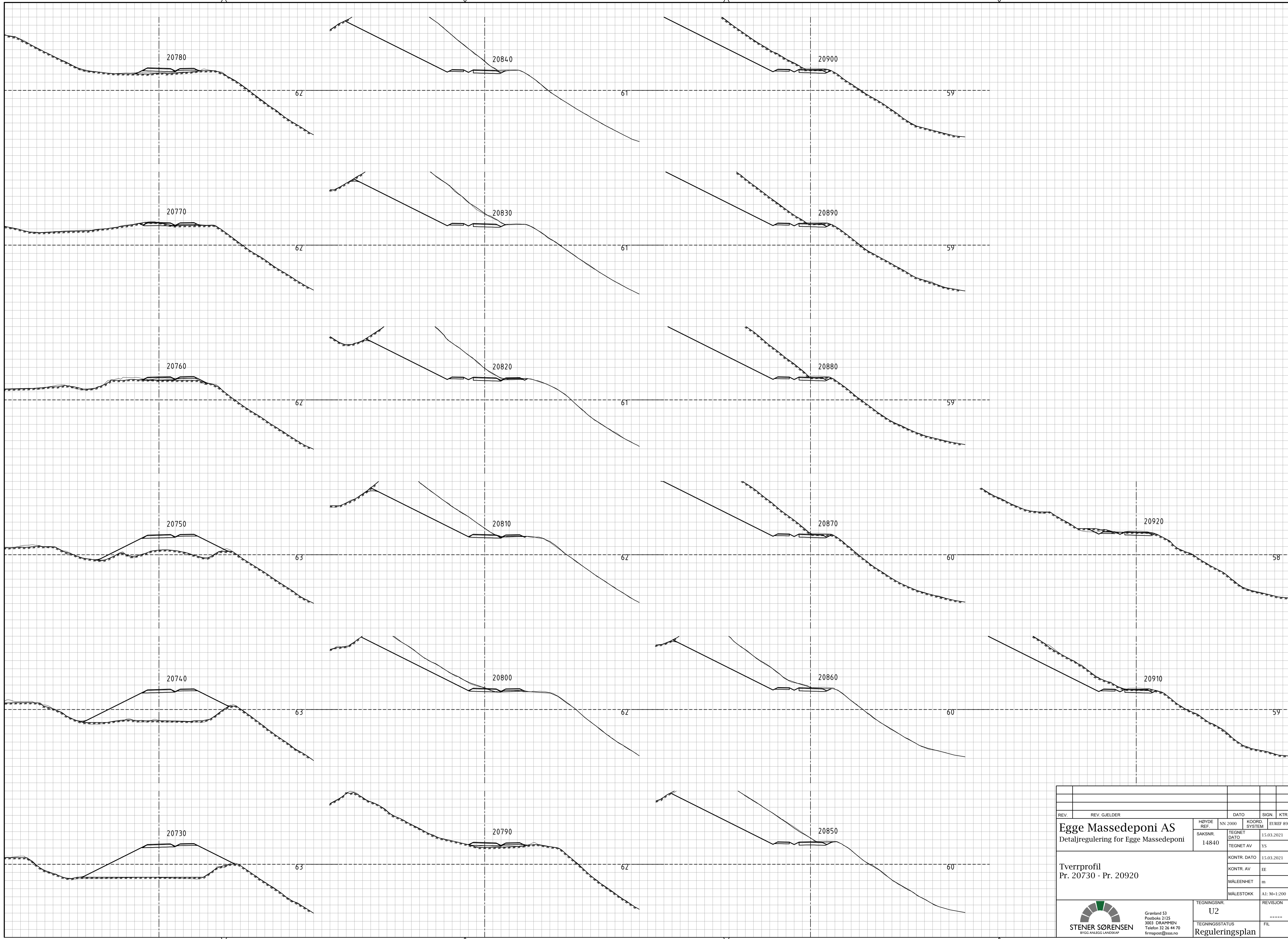

REV.	REV. GJELDER	HOYDE REF.	SAKSNR.	TEGNET DATO	TEGNET AV	DATO	COORD. SYSTEM	SIGN.	KTR.
		NN 2000	14840	15.03.2021	YS	15.03.2021	EUREF 89		
Reguleringsplan Egge Massedeponi AS Detaljregulering for Egge Massedeponi						TEGNINGSNR. U2 TEGNINGSSTATUS REVISJON			
Tverrprofil Pr. 20730 - Pr. 20920						KONTR. DATO KONTR. AV MALEENHET MALESTOKK			
 STENER SØRENSEN BYGG ANLEGG LANDSKAP						Grenland 53 Postboks 2125 3003 DRAMMEN Telefon 32 26 44 70 firmapost@stas.no			